

Art. 11006/1

AGILE LIGHT *plus*

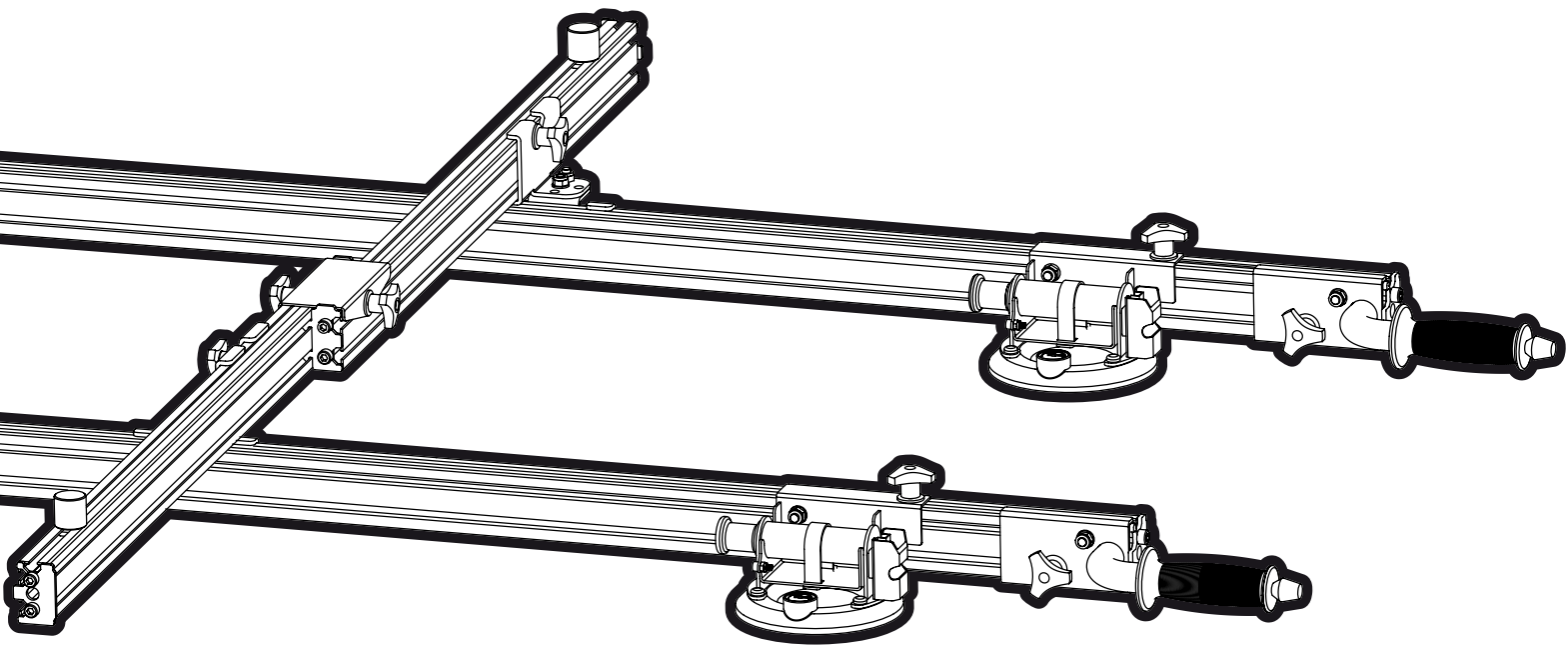

User Manual



BATTIPAVTM

IT

**ISTRUZIONI PER L'USO DEL
AGILE LIGHT SYSTEM SOLLEVATORE GRANDI FORMATI**

GB

**INSTRUCTIONS FOR USE OF THE
AGILE LIGHT SYSTEM LARGE FORMAT LIFTER**

FR

**MANUEL D'INSTRUCTION POUR LE
SYSTÈME D'ÉCLAIRAGE AGILE ASCENSEUR GRAND FORMAT**

DE

**ANWEISUNGSHANDBUCH FÜR DAS
AGILES BELEUCHTUNGSSYSTEM GROSSFORMATAUFZUG**

ES

**MANUAL DE INSTRUCCIONES DEL
SISTEMA DE ILUMINACIÓN ÁGIL ELEVADOR DE GRAN FORMATO**

NL

**HANDLEIDING VOOR HET
GROOT FORMAAT HEFBAAR BEHENDIG VERLICHTINGSSYSTEEM**



ATTENZIONE - ATTENTION - ATTENTION - ACHTUNG - ATENCIÓN - ATTENTIE

Articoli destinati a personale specializzato nelle operazioni del settore delle costruzioni edili e di posa pavimentazione e rivestimenti di grande formato. • Items for specialised personnel in building construction and large-format flooring and wall-laying operations. • Articles destinés au personnel spécialisé dans la construction de bâtiments et les opérations de pose de revêtements de sol et de murs de grand format. • Artikel für Fachpersonal im Hochbau und für großformatige Bodenbelags- und Wandverlegearbeiten. • Artículos para personal especializado en construcción de edificios y operaciones de pavimentación y revestimiento de gran formato. • Items voor gespecialiseerd personeel in de bouw en grootformaat vloer- en wandlegwerkzaamheden

	INFORMAZIONI TECNICHE ¹			INFORMAZIONI IMBALLO ²		
ARTICOLO ³	MASSIMA CAPACITÀ DI CARICO ⁴	MAX/MIN LUNGHEZZA BARRA ⁵	MAX/MIN LARGHEZZA BARRA ⁶	 7	 8	 9
AGILE LIGHT PLUS (Art. 11006/1)	160 Kg	3300 mm - 1720 mm	1580 mm - 840 mm	1795x640 x255 mm	8pz	650x1795 x2060 mm

1) Informazioni tecniche

Technical info - Informations techniques - Technische Informationen - Información técnica - Technische informatie

2) Informazioni Imballo

Packaging info - Informations sur l'emballage - Informationen zur Verpackung - Información sobre envases - Informatie over de verpakking

3) Articolo

Article - Article - Artikel - Artículo - Artikel

4) Massima capacità di carico

Maximum load capacity - Capacité de charge maximale - Maximale Tragfähigkeit - Capacidad de carga máxima - Maximaal draagvermogen

5) Max/Min lunghezza barra

Max/Min bar length - Longueur de la barre Max/Min - Max/Min Stablänge - Longitud máx./mín. de la barra - Max/Min staaflengte

6) Max/Min larghezza barra

Max/Min bar width - Largeur de barre Max/Min - Max/Min Balkenbreite - Anchura máx./mín. de la barra - Max./min. breedte van balk

7) Dimensioni imballo singolo

Single package dimensions - Dimensions de l'emballage unique - Abmessungen der Einzelverpackung - Dimensiones de un solo envase - Afmetingen enkelvoudige verpakking

8) Quantitativo pezzi per pallet

Quantité de pièces par palette - Anzahl der Stücke pro Palette - Cantidad de piezas por paleta - Aantal stuks per pallet

9) Dimensioni pallet completo

Dimensions de la palette complète - Vollständige Palettenabmessungen - Dimensiones del palé completo - Volledige palletafmetingen

Art. 11006/1

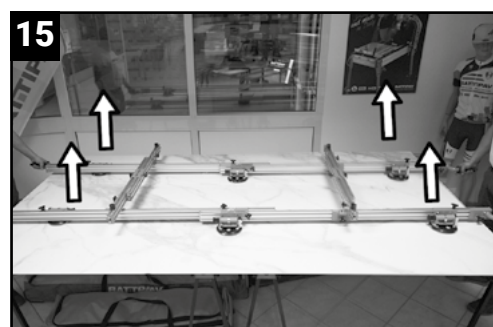
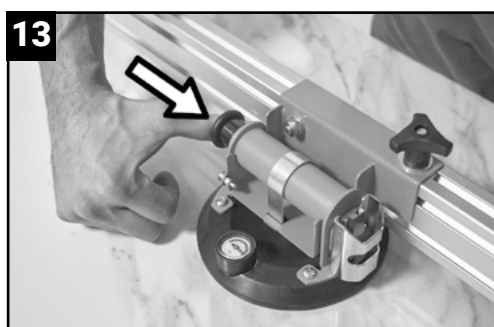
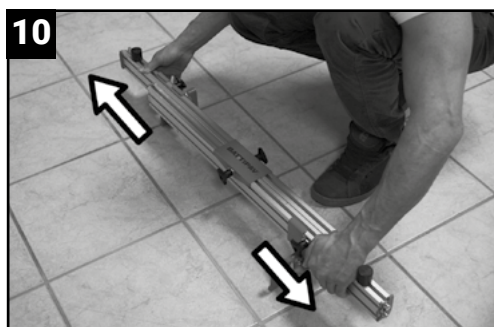
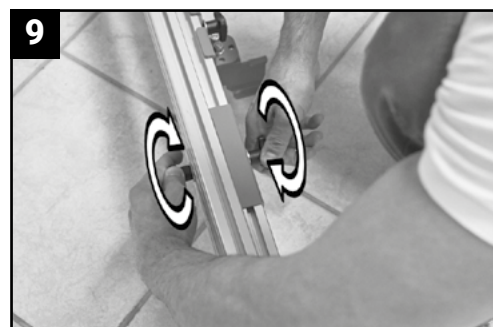
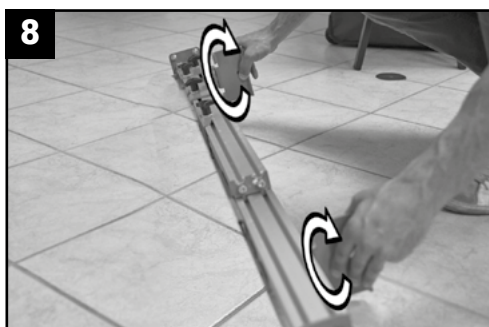
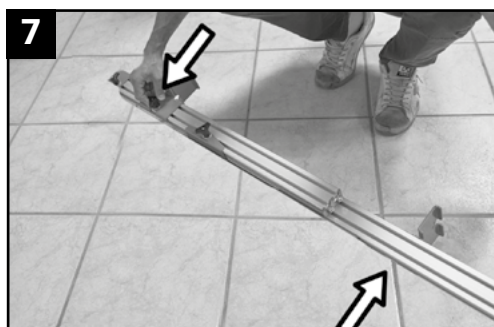
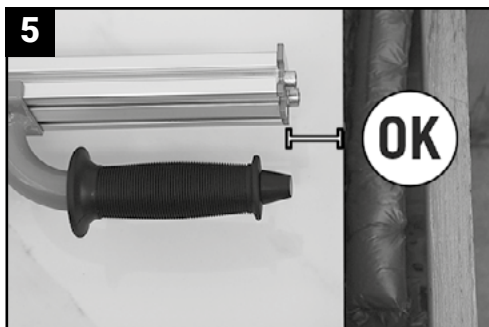
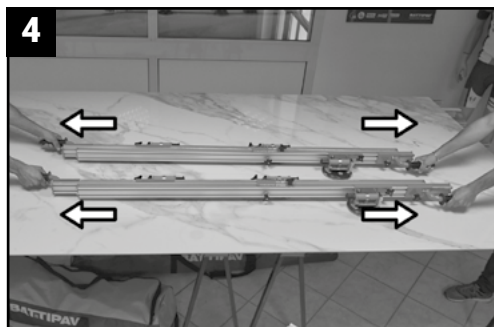

Art. 11006/1

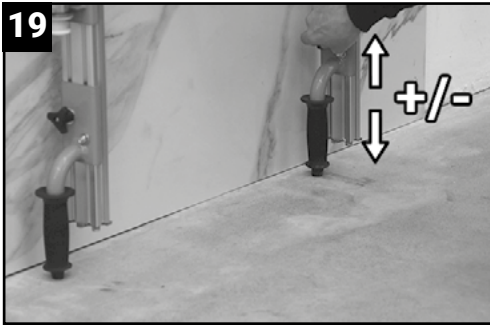
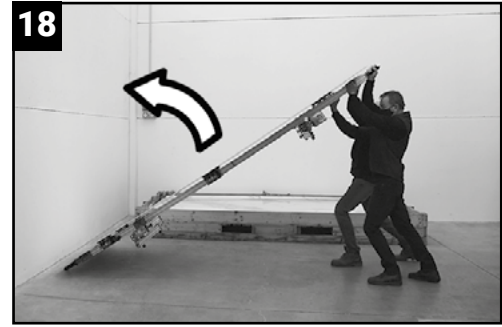
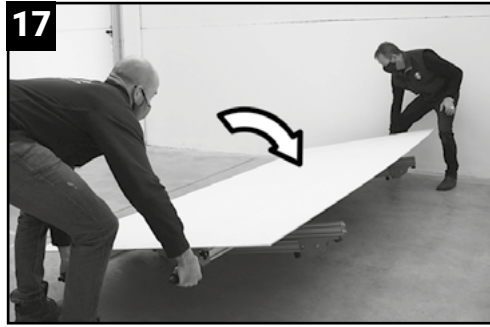

**CHECK THE PRODUCT VIDEO
CLICK HERE**



BATTIPAV™

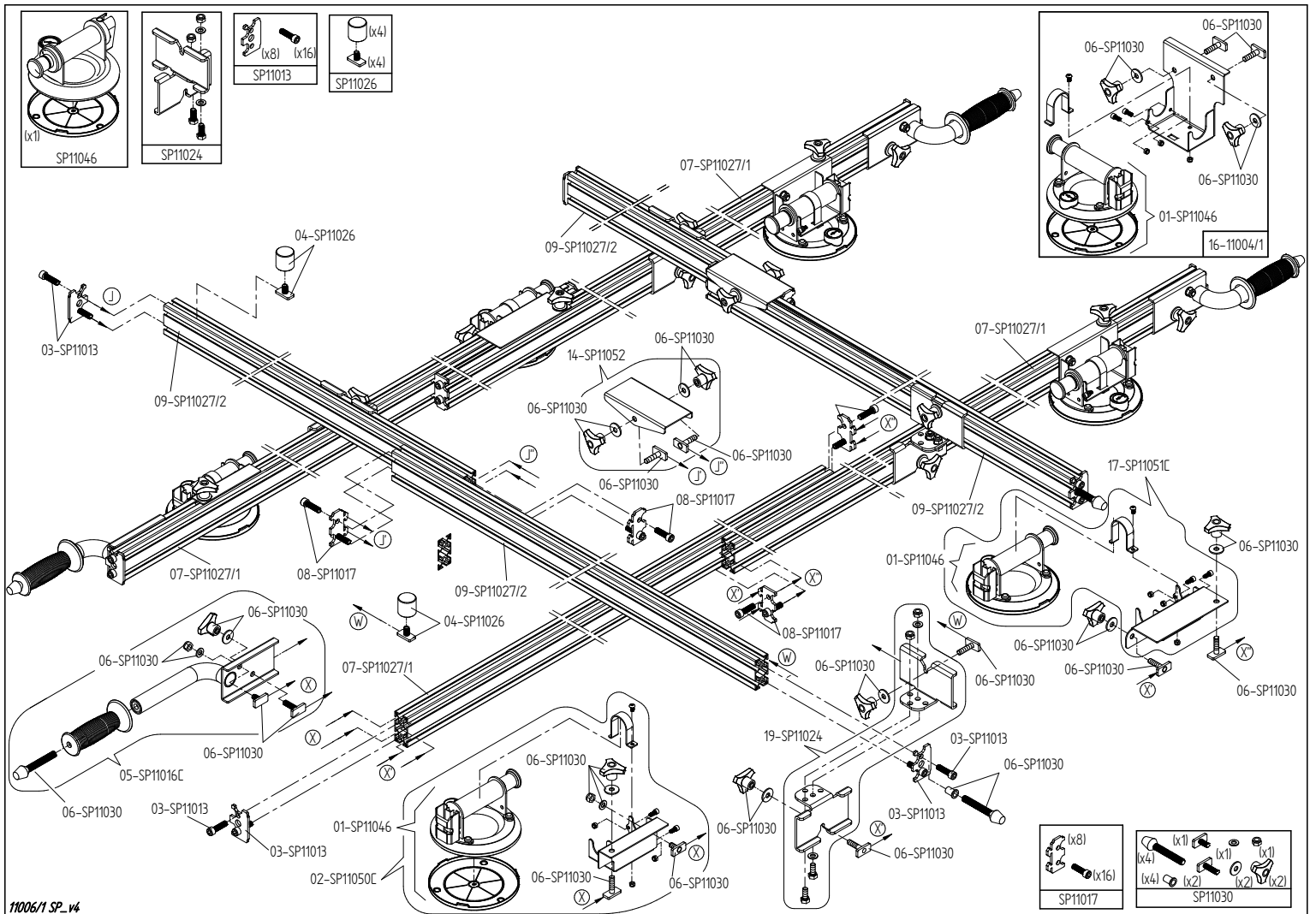



www.battipav.com

*La riproduzione anche parziale e la divulgazione di questo documento, con qualsiasi mezzo, non sono consentite.
Eventuali infrazioni saranno perseguite nei modi e nei tempi previsti dalla legge. Edizione 2020. Con riserva di modifiche.*

*Reproduction, even in part, and dissemination of this document by any means whatsoever is not permitted.
Any infringements will be prosecuted in the manner and within the time limits prescribed by law. Edition 2020. Subject to change.*

*La reproduction, même partielle, et la diffusion de ce document par quelque moyen que ce soit sont interdites.
Toute infraction sera poursuivie dans les formes et délais prescrits par la loi. Édition 2020. Sous réserve de modifications.*